

Article number: 03508120

Description: Fluro Rod end GE 120FW-2RS

Measures

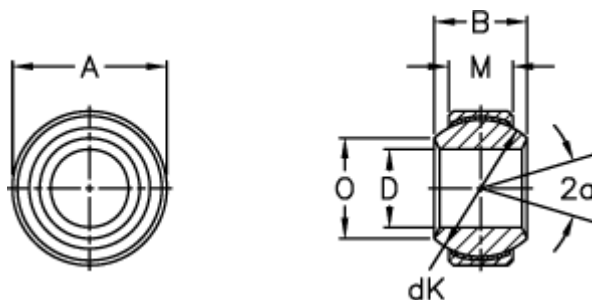

A = 210 0 -0,030

B = 115

D = 120 0 -0,020

dK = 180

Dynamic load C (kN) = 2010

M = 70

O = 138.4

Static load C0 (kN) = 4020

Tilt angle = 16

Weight = 14600